





















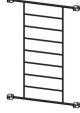



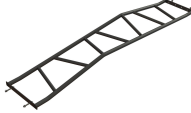

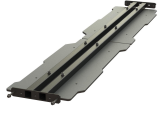
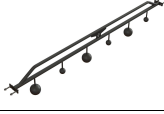

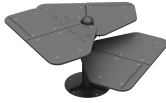



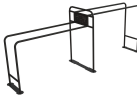



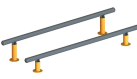



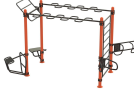





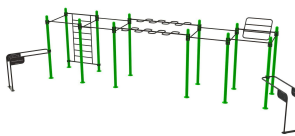

SKU/NAME	Model	Price (0% VAT)
BASIC ELEMENTS		
20-00471 PILLAR		246
20-00314 PULLUP BAR		195
BASIC ATTACHMENTS		
20-00695 MULTI GRIP BAR		259
20-00355 MONKEY BAR		460
20-01639 CHALKBOARD		614
20-01201 PLYO PLATFORM		512
20-01065 ROW PUSH UP DIP BAR ASSISTED SQUAT		435
20-06023 SHELF		160
20-03206 LONG DIP BARS		876
20-00525 SIT UP PUSH UP GHD		547
20-02339 BOARD FOR STANDING PUSH UPS		425
20-01268 FLYING PULL UP BAR		464

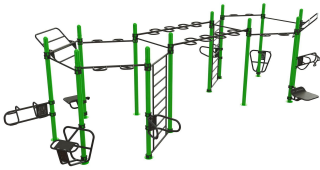
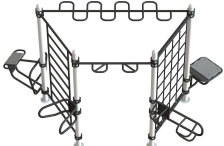
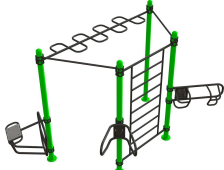
SKU/NAME	Model	Price (0% VAT)
20-00520 V-SHAPE DIP BARS		428
20-00943 LADDER		742
OCR ATTACHMENTS		
20-06021 VORTEX		992
20-06020 OUTDOOR CLIMBING NET		2173
20-05672 ATTACHABLE OUTDOOR DOUBLE SPHERES		86
20-05966 REVOLVER PULLUP BAR SET		2124
20-05092 ANGLED MONKEY BARS		387
20-05130 SWINGING BEAM		553
20-05952 SWINGING MONKEY BARS		1772
20-05875 CURVED BRIDGE		989
20-05107 MONKEY BAR		393
20-05104 MONKEY BAR H		486
GROUND OBSTACLES / FREE STANDING ELEMENTS		

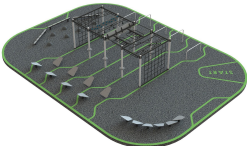

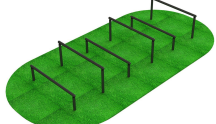

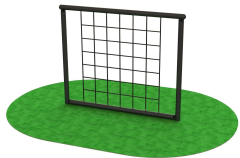
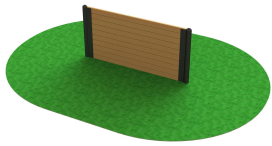
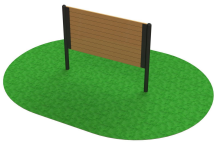
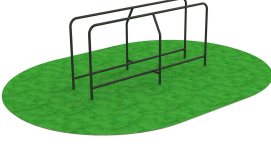
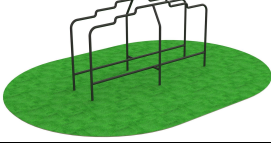
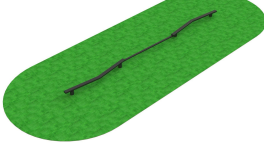

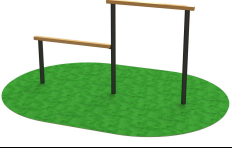
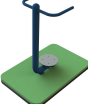
SKU/NAME	Model	Price (0% VAT)
20-00400B MULTI-LEVEL PLYO PLATFORM (40-50-60)		998
20-00446 PUSH-UP STATION		436
20-04256 FLAT BALANCE BEAM		492
20-04533 UNSTABLE FLAT BALANCE BEAM		648
20-02442 DIP BARS 1400 / 1500		1198
30-05202 NINJA STEPS		2832
30-06000 RUNNING CURVE		1416
30-05122 UP AND DOWN		536
30-02343 ROUND BALANCE BEAM SET		972
30-05476 LONG RUNNING CURVE		2124
30-05998 BALANCE COURSE		1632
20-05475 NINJA SPHERES		1120
OUTDOOR FITNESS STATIONS		
30-01076		5165

SKU/NAME	Model	Price (0% VAT)
30-03820-A-0001		1136
30-03850-C-0003A01		6618
30-03870-D-0001		5760
30-03870-D-0004		6947
30-03840-B-0001		3203
30-03850-C-0002		5770
30-03860-C1-0001		9370
30-03840-B-0002		2326
30-03850-C-0001		5146

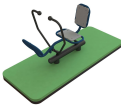
SKU/NAME	Model	Price (0% VAT)
30-03880-D1-0001		7219
30-03880-D1-0003		12211
30-03890-D2-0002		6109
30-03890-D2-0001		4038
30-03860-C1-0003		7050
NINJA PARKS AND OBSTACLE COURSES		
30-06313 NINJA PARK		24576
20-06752 WEAVER		1640
20-06759 OVER UNDER		1755

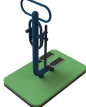
SKU/NAME	Model	Price (0% VAT)
20-06827 NET WALL		2625
20-06825 WALL		940
20-06826 WALL OR CRAWL		940
20-06815 DIP WALK		980
20-06850 DIP STEPS		1180
20-06855 BALANCE WALK		740
20-06829 STEP UP		920
20-06863 PEAK		1755
20-06843 IRISH TABLE		542
GYM FOR PARKS AND TRAILS		
30-07175 HIP TWISTER		450

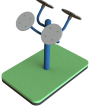
Outdoor Fitness equipment Price List 2021

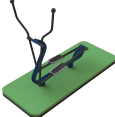
SKU/NAME	Model	Price (0% VAT)
30-07086 ROW MACHINE		780
30-07107 LEG PRESS		960
30-07160 LEG SWING		720
30-07185 ARM PRESS		990
30-07049 AIR WALK		790
30-07180 HAND ROTOR		700
30-07057 HIP SWING		740
30-07070 CROSS TRAINER		930